

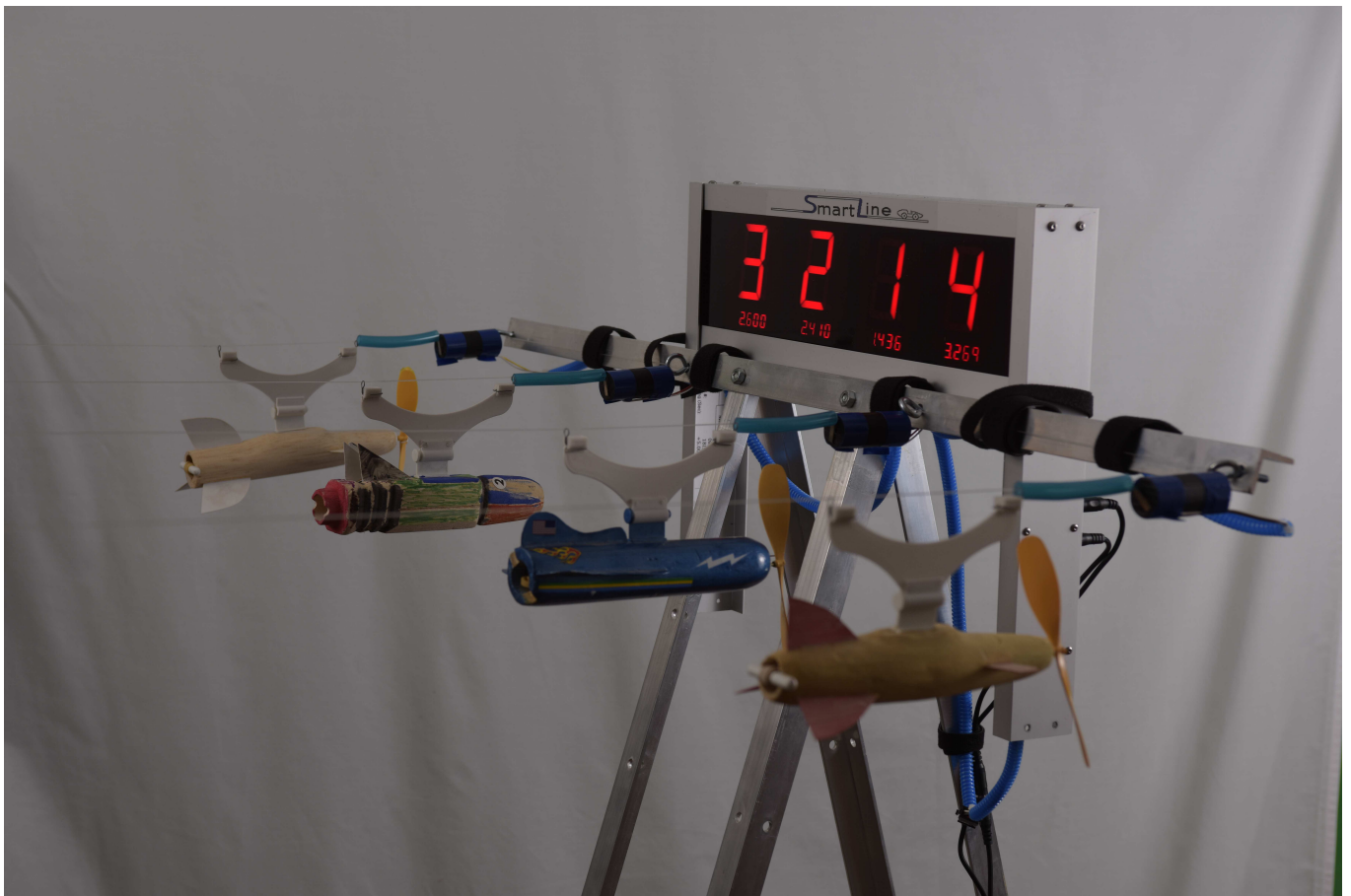

# SPACE DERBY MANUAL

## Wire Mounted Sensor Version

VERSION 9



eTekGadget  
36 Matuk Drive  
Hyde Park, NY 12538  
(845)-229-5189

[www.eTekGadget.com](http://www.eTekGadget.com)

Copyright © 2004 eTekGadget. All Rights Reserved.



## SmartLine Space Timer II

Thank you for purchasing the Complete SmartLine Space Timer II or the SmartLine Space Sensor Retrofit System. This manual will assist you with the installation of the original SmartLine Timer, the SmartLine II or the Champ onto either the BestTrack or BSA wooden frame of the Space Derby track. We ask that you use these instructions as a guideline and offer any input that will improve our product.

### Specially Designed Wire Mount Switch Sensors

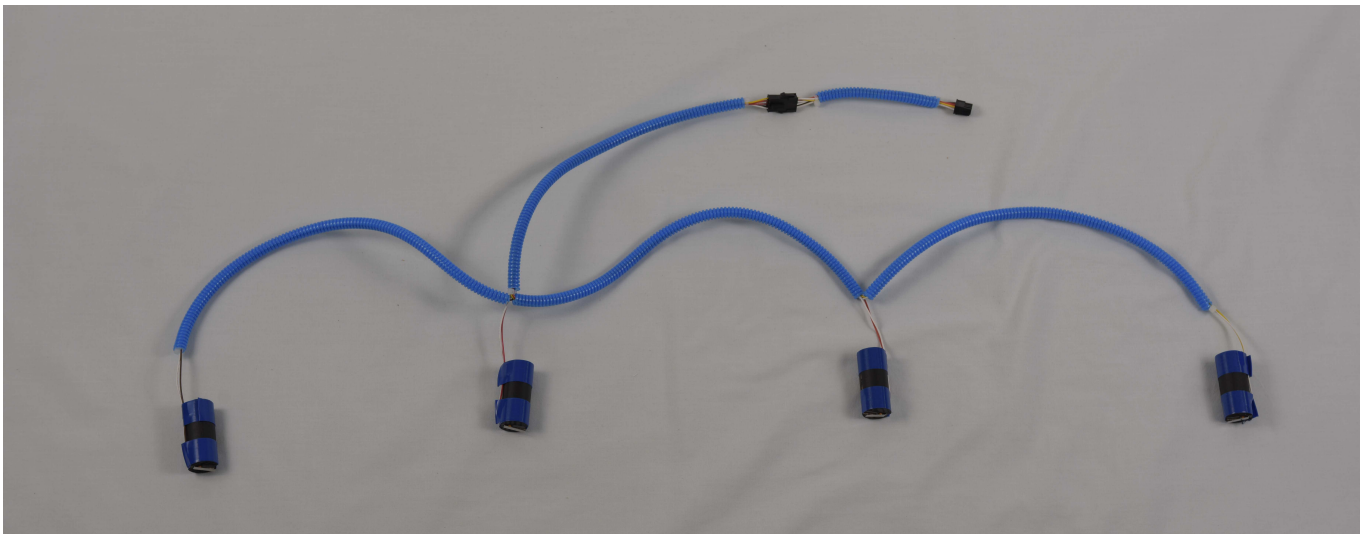

The sensors we supply are made up of a momentary switch mounted in a specifically designed housing that is mounted onto the Space track wire with vinyl friction tape. There is one sensor for each lane of a four(4) lane track.

The four sensors may be connected to a SmartLine Timer I, SmartLine Timer II or a Champ Timer.

If you have an existing SmartLine Timer I, the wiring of the sensors will be slightly different. The connector will be a white connector that matches the original timers connector and the wire extends from lane 1 to the timer. This is due to the proximity of the plug on the CPU board.

The SmartLine Timer II and Champ Timer sensors are wired as in the picture above with the black connector that matches the connector on the CPU board and extends from lane 2. We also supply a 4" extension cable that makes it easier to unplug from the CPU board. This extension cable may be left on the timer when you replace the Pinewood sensors on the timer.

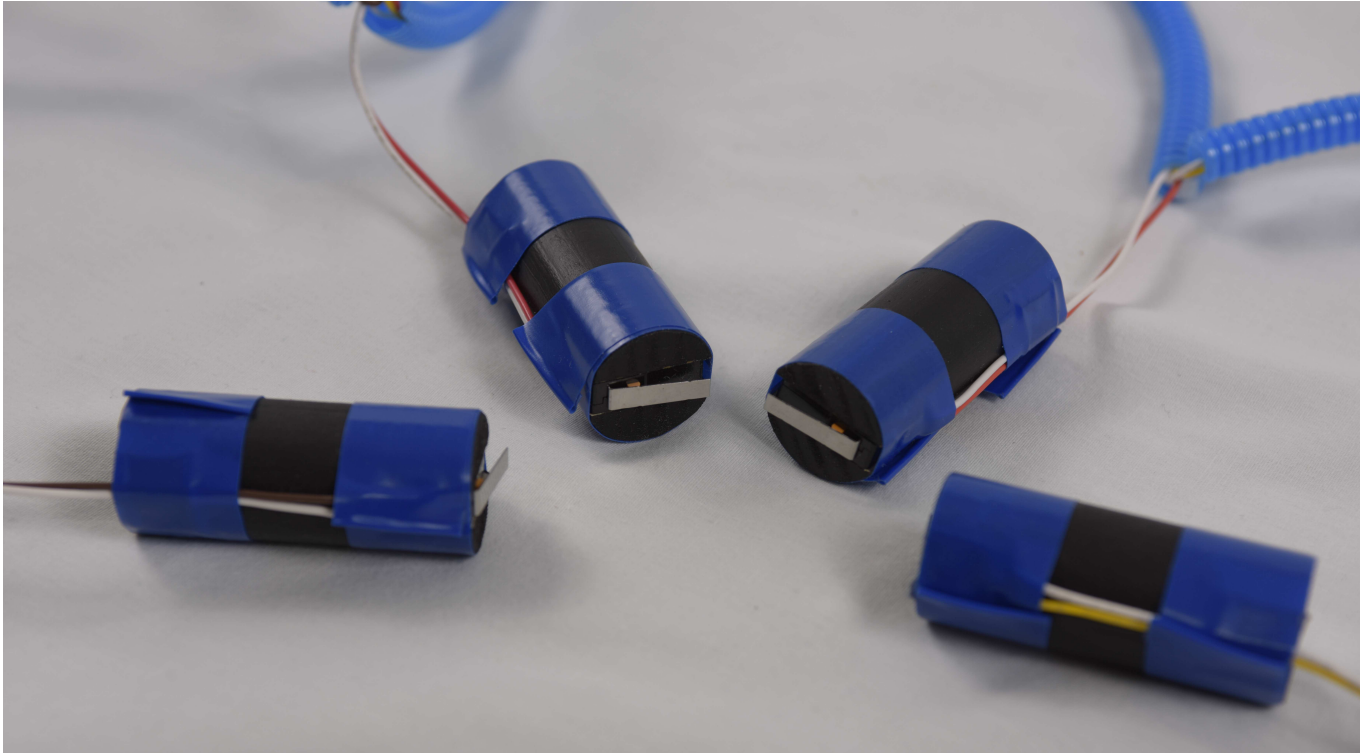

What is the specifically designed housing of the sensors?

The switches sit snugly at the end of the housing with heat shrink holding the wires close to the side. On the opposite side there is a groove that fits onto the Space track line. The electrical vinyl friction tape is placed at the front and back of the sensors.

Why do we use electrical vinyl friction tape? The vinyl tape keeps the fishing line snug in the groove in the top of the sensors housing. The adhesive on the tape prevents the sensor from changing position along the length of the fishing line. We supply a colorful roll of tape for you to use and keep with the sensors for future uses.

## Assemble or Build the Space Derby Track

You can use either the aluminum BestTrack Space Derby track or the BSA wooden frame from the BSA How-To-Book.

You will need to assemble the BestTrack Space Derby track as shown in “BestTrack’s Space Derby Track Instructions Manual”. A copy of the “Space Derby Track Instructions” can be found on our Manuals page on our website.

-OR-

You will need to build the Space Derby track as shown in Figure 1 Basic Track diagram on the next page. These plans are from the BSA How-To-Book.

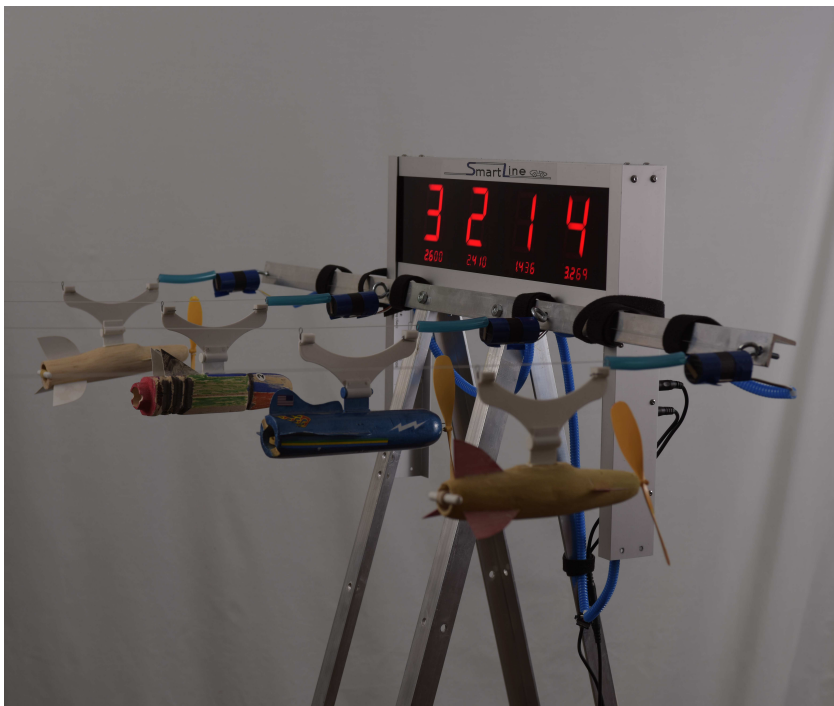

Picture to the left is the front of BestTrack Track with the Complete SmartLine Space Timer II.

If you have a Pinewood Timer II or Champ, you must remove the Pinewood mounting bar from the bottom of the timer when mounting to the Space Track.

## Basic Track Plan from the BSA How-To Book

The BSA How-To Book shows the dimensions of a basic track. A good choice of wood for construction is 1"x3".

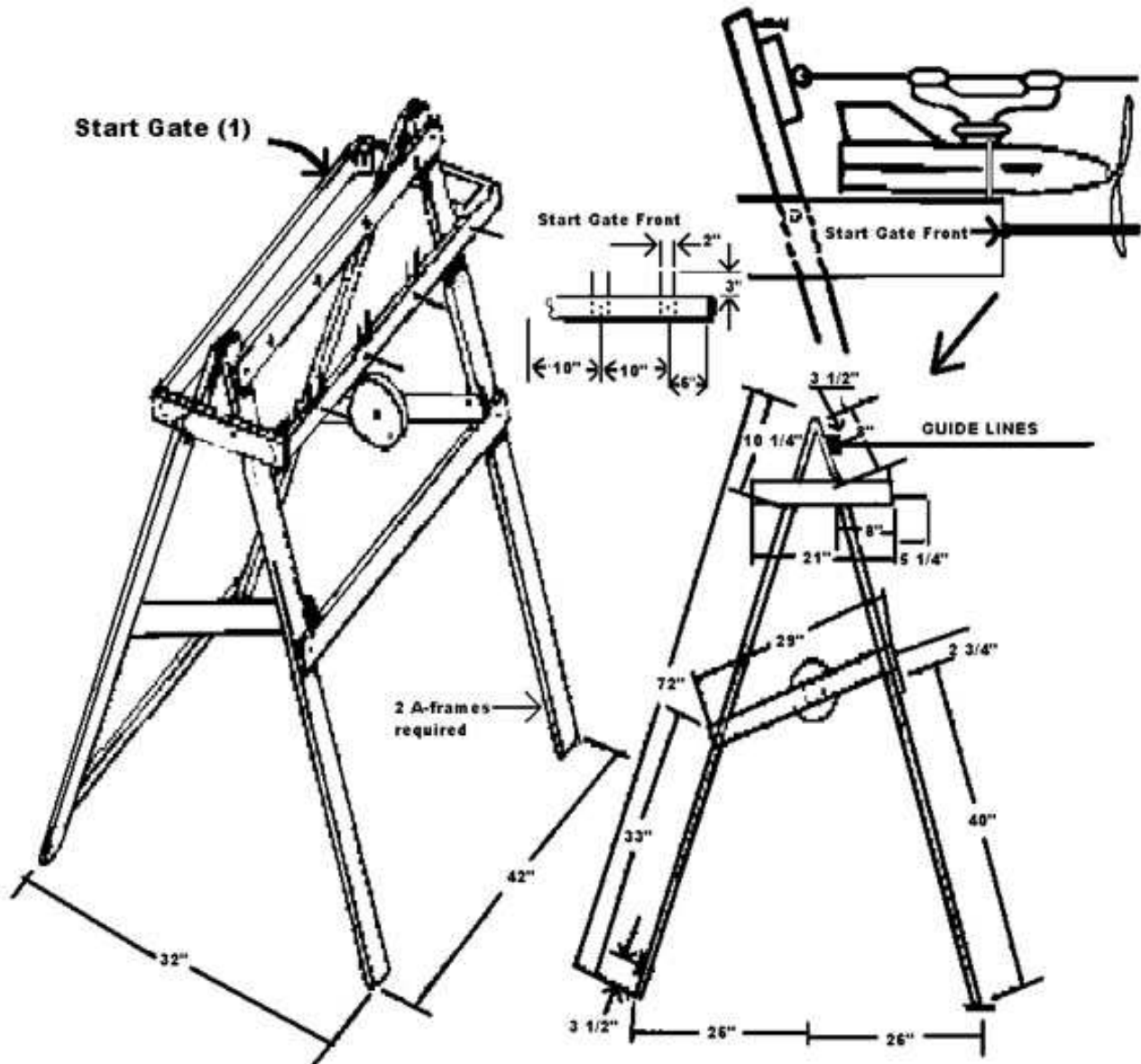
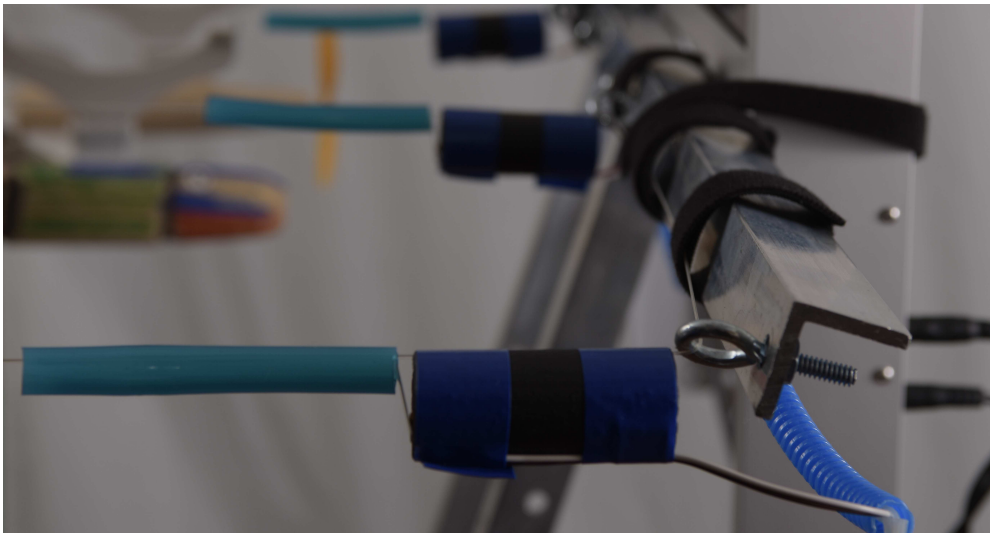

Figure 1 Basic Track

## Line, Tubes, Carrier and Sensor Mounting

**Mount the carriers and stop tubes onto the line as you string it onto the track.**

String the carrier onto the line as shown in the track instructions. We supply the plastic tubes that are to be mounted in front of the sensor switch so that the propeller will not hit the sensor. The best way to install them is to slide them onto the string before tying the string onto the frame. If you do this, make sure you place them on the correct side of the carrier. There is a slit in the tube so you may slip them on after the sensor switch is mounted as well.



This picture shows you how the sensor and plastic stop tube should be mounted on the wire.

**Install a sensor switch onto each lane after the line is installed.**

Each sensor must be mounted on the fishing line wire with the **vinyl friction tape**. We send it with a piece of tape already installed so all you need to do is peel the tape back and fold it over the wire to install the sensor. **Make sure to place the wire into the groove.** Go to our website Instructional Videos page to see how to install them correctly.

On subsequent installations, if you need to replace the tape, make sure that the tape is close to the front of the sensor so that the switch is held close to the wire.

Please refer to the position of the tape on the sensor in the picture below.





## SmartLine Timer Computer Unit (CPU) mounting If you have a SmartLine II or Champ skip this.

Mount the SmartLine CPU onto the track.

We supply the self-grip Velcro wraps to secure the CPU and wires in place under the bar. If you are mounting the timer to a wooden frame, you may use the Velcro to hold it in place behind the horizontal bar.

The power, communication and start switch wires should be **taped** to the leg of the track so they will not pull on the CPU if someone trips on them.

Please refer to the pictures at the end of this document for more details.

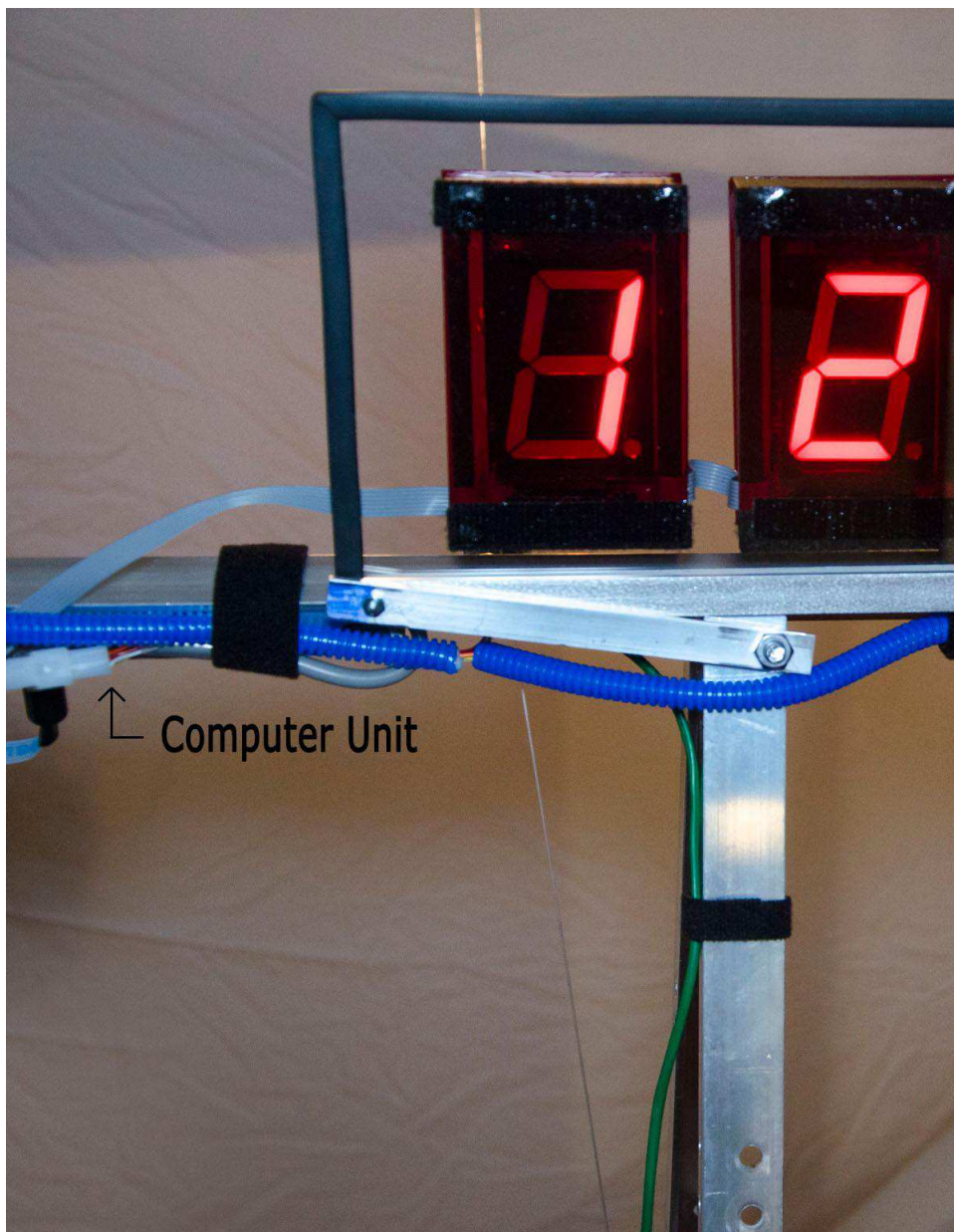

## SmartLine Timer II and Champ Display Mounting

Mount the SmartLine II or BestTrack Champ Timer onto the track frame as shown below.



You must remove the bottom sensor bar from the SmartLine Timer II or Champ. It is not needed and will allow the displays to sit upright. It will be easier to unplug and plug in the sensors as well.



Unplug the Pinewood Derby Sensors from the CPU board.

We send a short extension sensor cable that may be left on your timer when reinstalling the Pinewood Sensors. This makes it easier to attach them in the future. The extension is shown at the right.

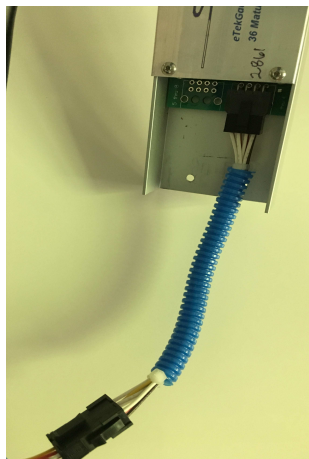
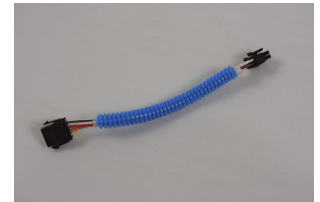

Plug the Space Derby Sensors into the CPU board.

Attach two(2) ¼-20 hex head bolts (approximately 3 inches long) into the spare holes at the back of the BestTrack frame using two(2) each hex head nuts on the outside and two(2) on the inside.

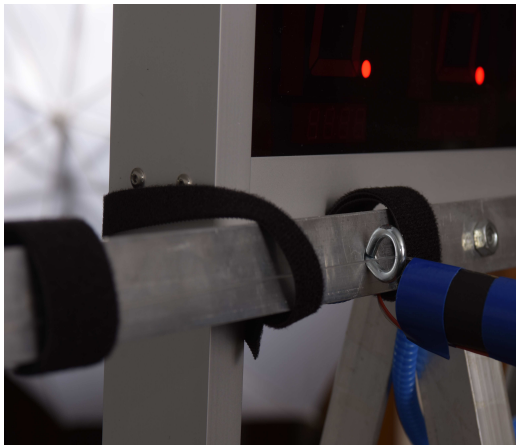
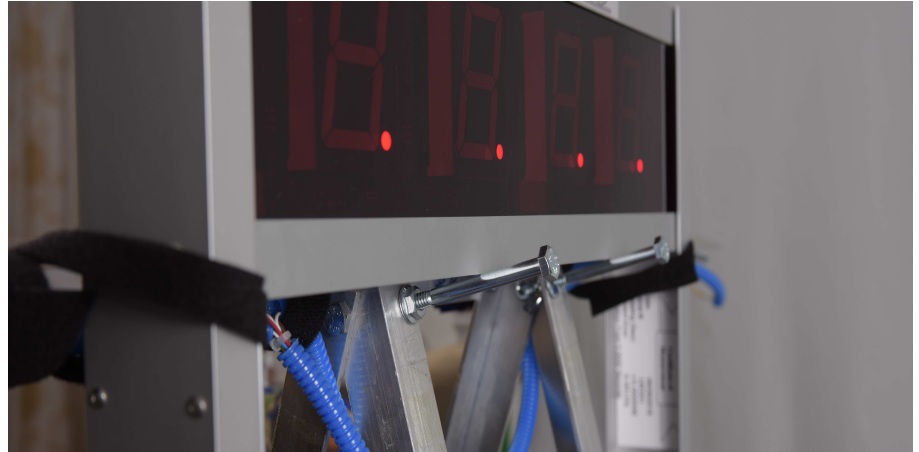

Wrap the self-stick Velcro around the legs of the timer and the track to hold it securely.

The power, communication and start switch wires should be **taped** to the leg of the track so they will not pull on the CPU if someone trips on them.

**Mount the SmartLine Display Plexiglas Panel onto the top of the BestTrack or BSA wooden track frame.**

**Skip this if you have a SmartLine II or Champ.**

Installation on the BestTrack Track:

We supply the Plexiglas Panel with 2 brackets designed to screw into spare holes in the BestTrack track. The nuts and bolts are provided.



Back view of the SmartLine timer I displays mounted onto BestTrack Space Derby Track

Wooden Frame installation:

You will need to drill holes in the wood at the current holes position. Mount the Plexiglas panel with wood screws onto the back of the BSA track frame.

## Add the Start Gate Switch

The start gate switch must be mounted on the starting gate frame. The timing is triggered in the timer when the switch is opened. See the start switch wiring directions below.

An easy way to tell if you have the start gate switch wired properly is when the cars or ships are racing down the track the displays will be showing a dash in the center of the display. When the dash is showing, the timer is timing. The dot on the displays indicates that the timer has reset, but the start gate is still open and needs to be shut. If you are using race management software, you must use the start switch.

We supply a large binder clip to hold the start gate switch onto the track as in the following pictures in the details section. You may attach it to a piece of metal or wood and bolt it to the track using one of the existing unused holes.

We supply a new Start/Reset button Harness and cable. You will have to install this in one of the holes close to where the switch will be mounted, make a new hole for it or attach it to the track leg. We supply an extra Velcro strip with stick for you.

## Details on installing the Start Gate Switch

- 1. WIRING INSTRUCTIONS:** The supplied sensor switch has three terminals marked C(Common), NC(Normally Closed) and NO(Normally Open). The preferred method is to have the switch pressed before the race and un-pressed when the race starts. This method requires the use of the C and NC contacts. **The timer is shipped with the green wire on C and the white wire on NC.**

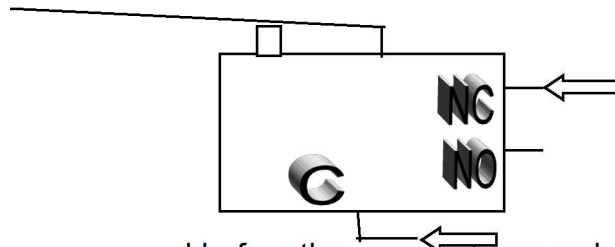

If you want the switch to be un-pressed before the race and pressed when the race starts, then the push-on terminal needs to be on the NO contact as indicated below.

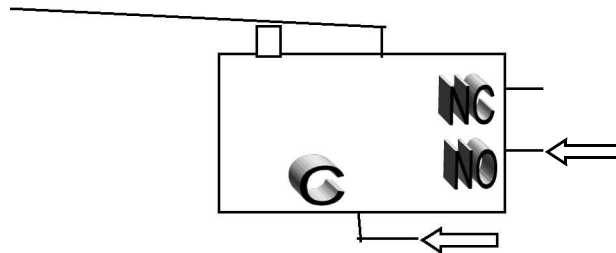

## Installing the Start Gate Switch on the BestTrack Track

The start gate switch shown below is mounted on the BestTrack track with large binder clip. You may decide to permanently mount the switch by attaching the switch to a metal or wood piece and bolting it to one of the existing unused holes in the track. The important thing is that the switch is depressed (closed) when the gate is closed and opens when the race starts as it is wired when shipped. You may use the bracket and self-tapping screws that are included in your package.

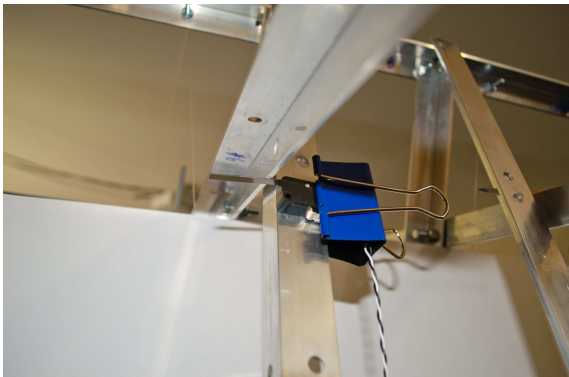
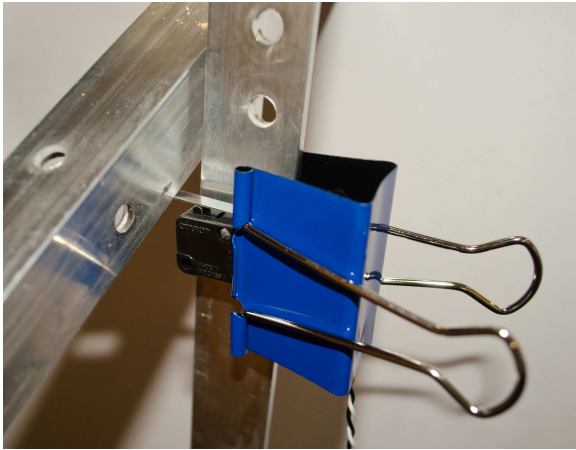

## Installing the Start Gate Switch on the BSA Wooden Track

The start gate switch mounted on the wooden BSA track as shown here:

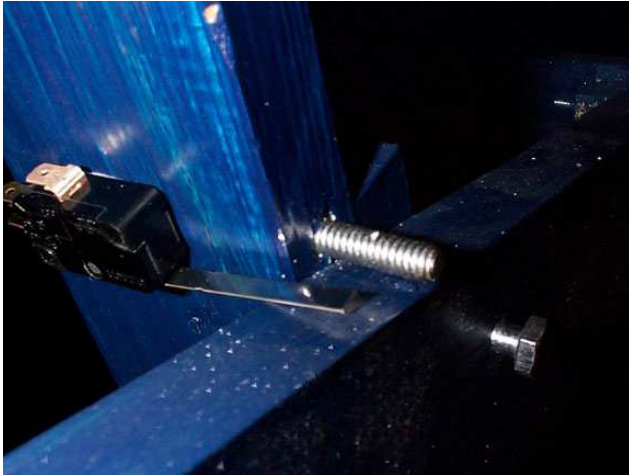

**Outside view 1- Closed Position**

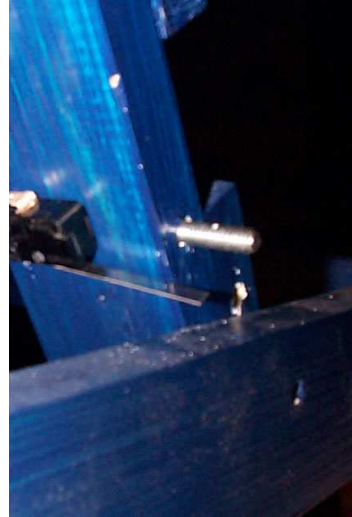

**Outside view 2- Open Position**

## Install and Run the SmartLine Setup Program

You may use the SmartLine Setup Program (LINESETUP4.EXE) provided on the CD as explained in the “SmartLine Pinewood Derby Quickstart instructions”. It is a utility program that is meant only to use for setting the various options such as automatic timeout. We set the automatic timeout to be 20 seconds.

To start the SmartLine Setup Program, simply double-click on the LINESETUP4.EXE program name. You will see the following screen:

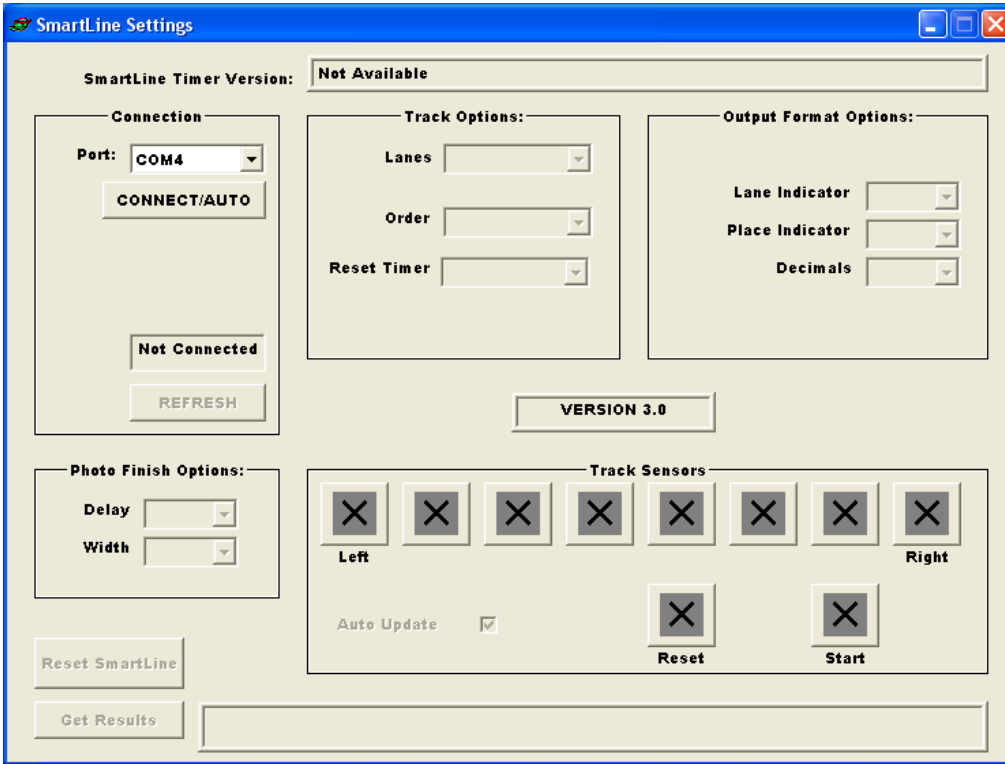

This is not a driver program for the timer. The timer does not need this program to operate.



## Additional Tips

Lubricate the rubber bands with glycerin. It is very beneficial to soak the rubber bands in two parts "GREEN SOAP", one part "GLYCERIN" and one part water. Rub this mixture onto your rubber band at least an hour before racing. Find more information and links about the lubricating solution on our FAQ page. You may also soak it overnight in castor oil. The rubber bands work better when they are soft and slippery.

You will probably find the green soap and glycerin at a pharmacy, Walmart or Amazon. Tincture of green soap is a mild liquid soap that contains isopropyl alcohol and glycerin, but no animal ingredients, dye or fillers.

Hang 3 rubber bands on the red hook of the propeller and feed them down through the ship. We have found that 3 rubber bands works well. They give you 4 but that gets too bunched up inside the ship and they sometimes won't unwind.

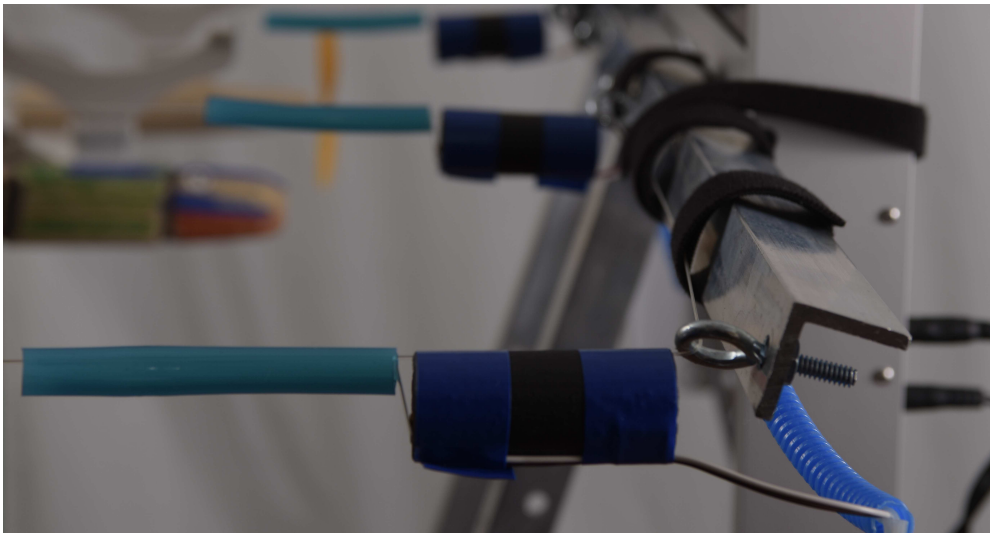

This picture shows you how the sensor and plastic stop tube should be mounted on the wire.



We are always striving to improve our products. If you have any comments or questions, please email us. Send any pictures, comments or suggestions to [nfritz@etekgadget.com](mailto:nfritz@etekgadget.com). We appreciate any input you can provide.

Thank you!

Nancy and Richard Fritz  
36 Matuk Drive  
Hyde Park, NY 12538  
(845)-229-5189  
[www.eTekGadget.com](http://www.eTekGadget.com)